

BU5 Counter Top Spec Sheet

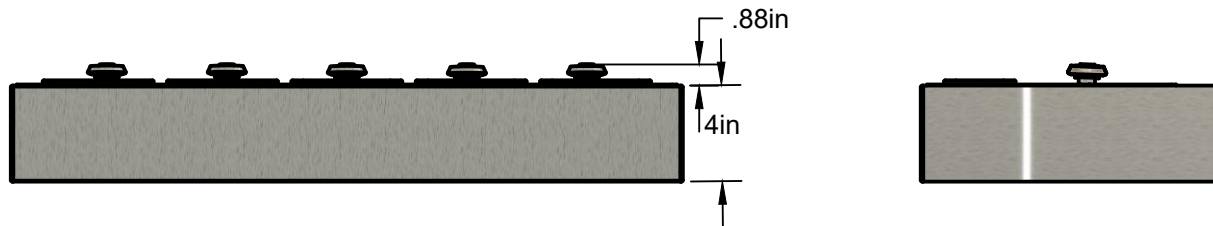

All Bottoms Up Dispensers come with LEDs that light up the beer while filling, 6 feet of drain line, mounting hardware, spare o-rings, and user instructions. Dispenser will be plumbed with 6 feet of high pressure glycol line *. A cooling system must be connected into the glycol lines to keep the beer cold up to the point of dispense. Underside of dispenser must be accessible for service work and cannot be permanently secured to the counter. Dispenser requires a standard 120VAC outlet within 10 feet of location.

Dispenser Specifications	
Number of Valves	5
Beer Line	6 feet of $\frac{3}{16}$ " id vinyl *
Certifications	NSF # C0217099
Power Requirements	1 Standard 120VAC outlet @ 2 Amps
Power Supply Approvals	UL / CUL / PSE / TUV / BSMI / CCC / CB / FCC / CE

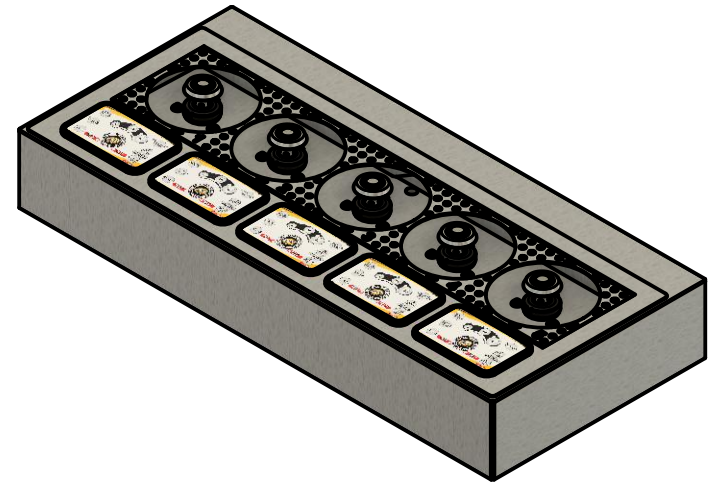
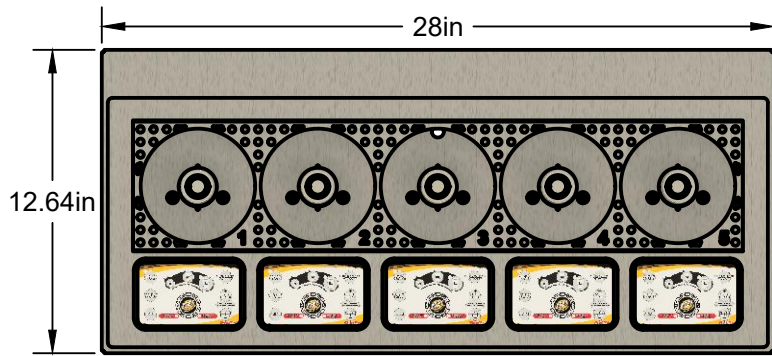

* $\frac{3}{16}$ " id vinyl line and high pressure glycol line may be increased up to 9 feet for long draw installations less than 50 feet or to accommodate for high elevation.

BU5 Tap Display Spec Sheet

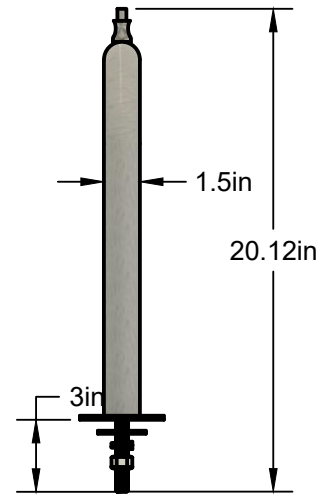
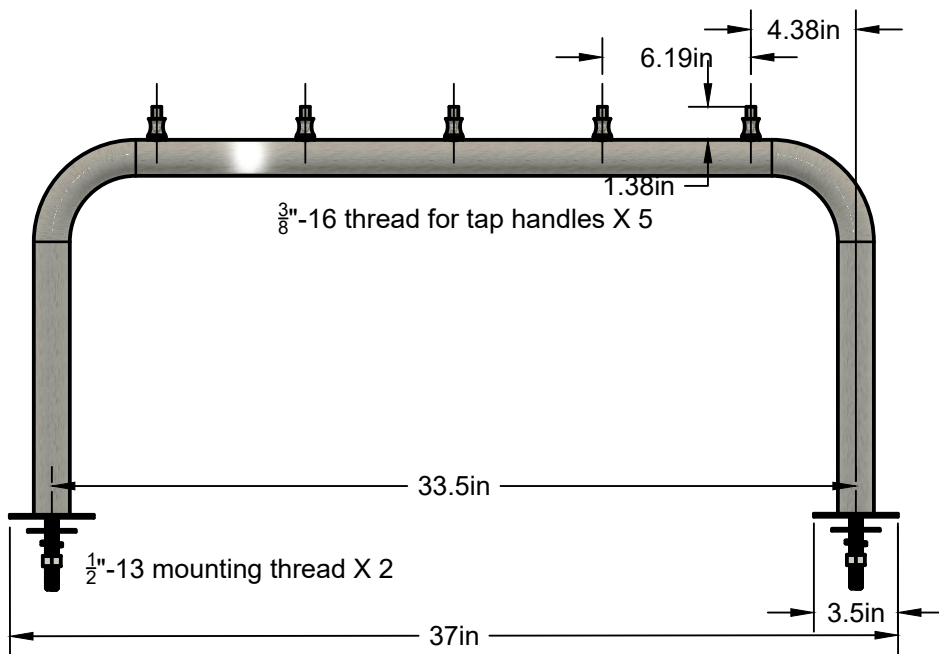
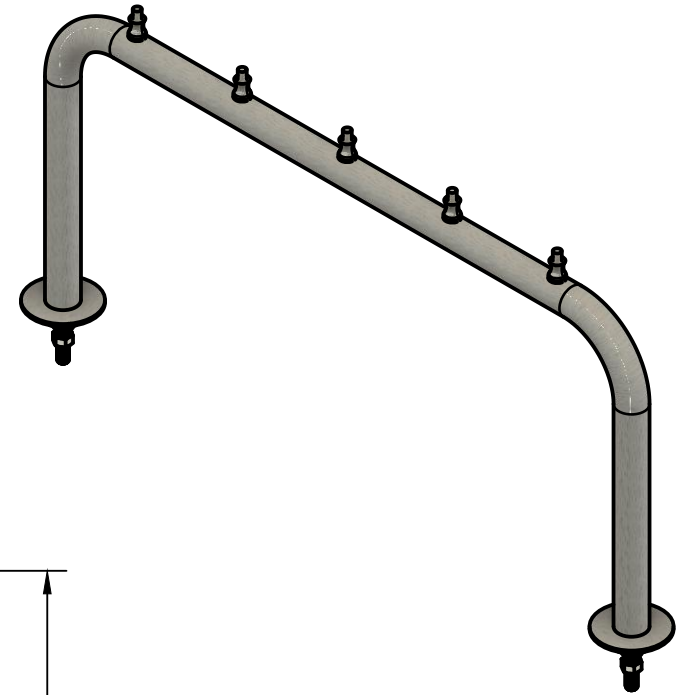
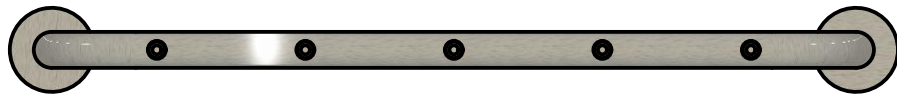

Tap Display is included with Dispenser. Wall mount or other type of display can be provided upon request.